

HD Matrix

USER MANUAL



Please read this manual carefully before installing the equipment and keep it for future use.

Caution

- In the installation and use of this product, the electrical safety regulations of the country and the use area must be strictly observed.
- Please take formal power supply unit, this device requests AC100V-220V.
- Be sure to disconnect the power supply during wiring, disassembly and other operations. Do not operate with live power.
- If there is abnormal on devices, please contact with your distributor or factory.
- don't remove and modify the equipment in any manner. (The manufacturer is not responsible for the problems caused by unauthorized modifications or repairs)

Attention

- Please do not make the object fall on the equipment or vigorously shake the equipment, and keep the equipment away from the place where there is magnetic interference. Avoid installing equipment on surfaces that are prone to vibration or shock (don't ignore this, it may damage the equipment).
- Please do not install and use in an environment that is too cold (below 0°C) or too hot (above 55°C);
- Please don't expose the devices to rain or moisture.
- Please don't use device in flammable or explosive gases or corrosive gases
- Please Provide good ventilation environment
- The Devices connect to the Internet may face network security problems, please strengthen the protection of personal information and data security.
- Please understand that it is your responsibility to properly secure all passwords and other related products and to keep your username and password safe
- To avoid fire or electric shock hazards, do not overload the power cord of the equipment.

Content

1.1 Product introduction	3
1.2 System capabilities overview.....	4
Part 2 Inspection before use	5
2.1 Open the package and check.....	5
2.2 Panel illustration	5
2.3 Dimensional drawing.....	6
Part 3 Installation and connection	7
3.1 System connection	8
3.2 Network setup	9
3.2.1 IP address search	9
Part 4 Matrix configuration.....	11
4.1 Log in to matrix configuration menu	11
4.2 Device configuration	14
4.2.1 System.....	14
4.2.2 OSD	15
4.3 Board configuration	16
4.4 Host configuration	17
4.5 Camera Configuration.....	18
4.5.1 RTSP Configuration	19
4.5.2 ONVIF configuration	20
4.5.3 Stream configuration	22
4.5.4 Encoder Stream	23

4.5.4 KVM.....	24
4.6 Video Screens configuration.....	25
4.7 Macro Switches	27
4.7.1 Patrol Switch	28
4.7.2 Split Switch.....	29
4.7.3 Group Switch	30
4.8 Alarms	31
4.8.1 Alarm point	32
4.8.2 Linkage actions.....	33
4.8.3 Settings	34
4.9 User configuration	35
4.10 IP Table configuration.....	36
4.11 Maintainance.....	37
4.12 Operation	38
4.12.1 Splitting&Splicing	39
4.12.2 Audio control&PTZ Control.....	40
4.12.3 Macros	41
4.12.3 Plans & Preset control	42
Part 5 Appendix.....	43
5.1 Specifications and parameters	43
5.2 HD Matrix fault analysis and debugging	45
5.3 communication matrix.....	46
5.4 User list	47

Part1 HD Matrix Introduction

1.1 Product introduction

HD network digital matrix can decode the Front-end high-definition network camera into High-definition digital signal and output to HD LCD equipment. It can accomplish multiple display modes by keyboard or net client software, including video splitting, splicing. HD Matrix can wake up the configuration page by mouse.

The product is functional, stable and easy handled, suitable for most network video surveillance places which require image decoding video wall. It is the easiest mode for Network surveillance, which is widely used for smart cities, public transportation (airport / station / subway), schools, exhibition halls, venues, large-screen display and other fields.

1.2 System capabilities overview

- ◆ Support network media input
- ◆ Support multiple resolution of output, it can manual set output resolution.
- ◆ Output supports maximum 3840x2160@60Hz.
- ◆ Support 4K, 1080P, 1080I, 720P, D1 video formats
- ◆ Support standard H.265 & H.264.
- ◆ Support 8ch 4K or 64ch 1080P or 128ch 720P decoding and display.
- ◆ Support video-splitting output, up to 25 windows split on one monitor
- ◆ Support Cruise, Plan, split, splicing, etc. display mode.
- ◆ Support Plan configuration and management.
- ◆ Support intelligent connection.
- ◆ Support audio input and output
- ◆ support alarm linkage trigger
- ◆ Support OSD, title, time and warning messages can overlap on the displayed video
- ◆ Support multiple label program, can configure label position freely.

Part 2 Inspection before use

2.1 Open the package and check

When you receive the HD Matrix, please check that the outer carton is damaged. The protection packing material inside the carton can protect the device from most accidental impact during shipping. If no damage then open the carton and verify the contents against your order. Verify that the power cable (or power supply), manual and software disk is included.

2.2 Panel illustration

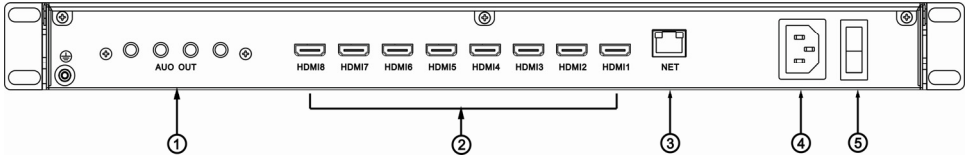

①	Audio input and output
②	HDMI output
③	100/1000M adaptive
④	Power port
⑤	Power supply switch

2.3 Dimensional drawing

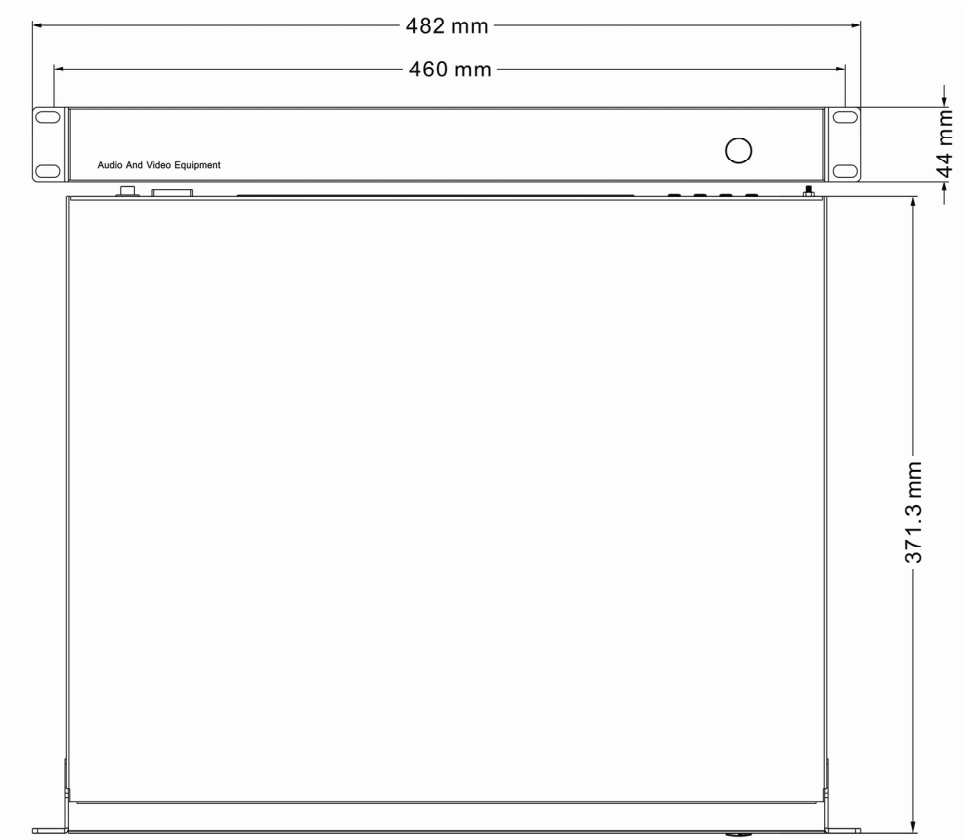

Part 3 Installation and connection

HD Matrix is designed according to the standard chassis structure. When installed with standard rack, you should maintain certain spacing away from other equipment for adequate ventilation.

All connection ports are installed on the rear facing panel. Do not apply power until all connections are made and verified.

Note:

- 1. Please read this manual carefully before terminating any connections or applying power to the equipment. Improper connections or voltage setting may result in permanent damage.***
- 2. The power must be grounded to prevent shock or permanent damage, endangering human safety.***

3.1 System connection

Make sure the HD Matrix, IP Cameras, stream media server, keyboard controller and computer are connected the same LAN network switch. Each HDMI output is connected to an HD video monitor using a high grade HDMI cable. Up to 16 HD screens can be spliced for monitoring.

Important: please ensure IP address of computer is configured in the same IP Scheme (octet) segment of HD matrix.

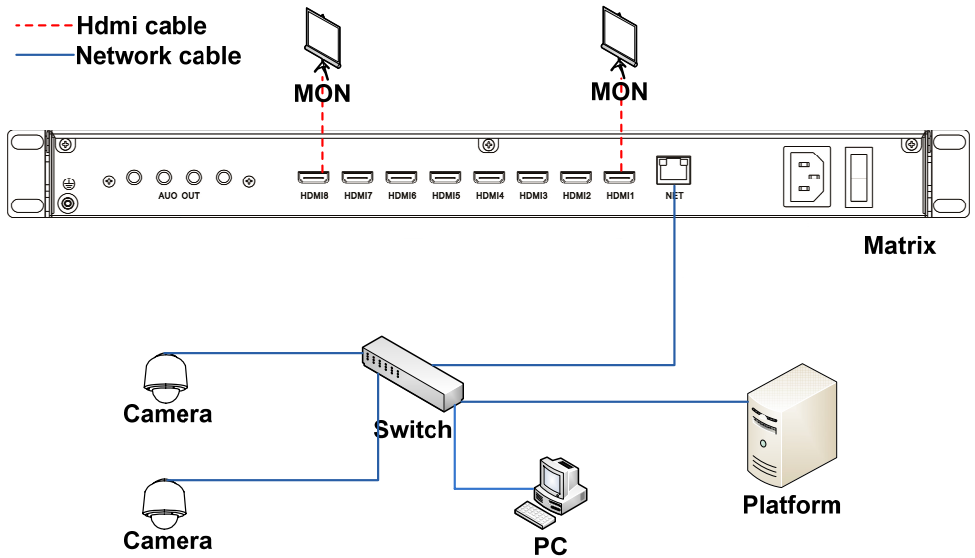

3.2 Network setup

After the hardware setup is completed, you will need to set the network parameters for HD Matrix.

When using the HD Matrix for the first time, please use the IpConfig.exe software supplied to search the MAC address, IP address, subnet mask and gateway of the HD Matrix.

When using the keyboard controller for the first time, you should consult the user manual to set up the keyboard's IP address and gateway, then input the HD Matrix's IP address, port and press [save].

Note: please ensure to set computer's IP, keyboard's IP and Matrix's IP in same octet segment.

3.2.1 IP address search

Using the IP Config search tool "IpConfig.exe", you should see the interface as shown in the following 3.1 figure.

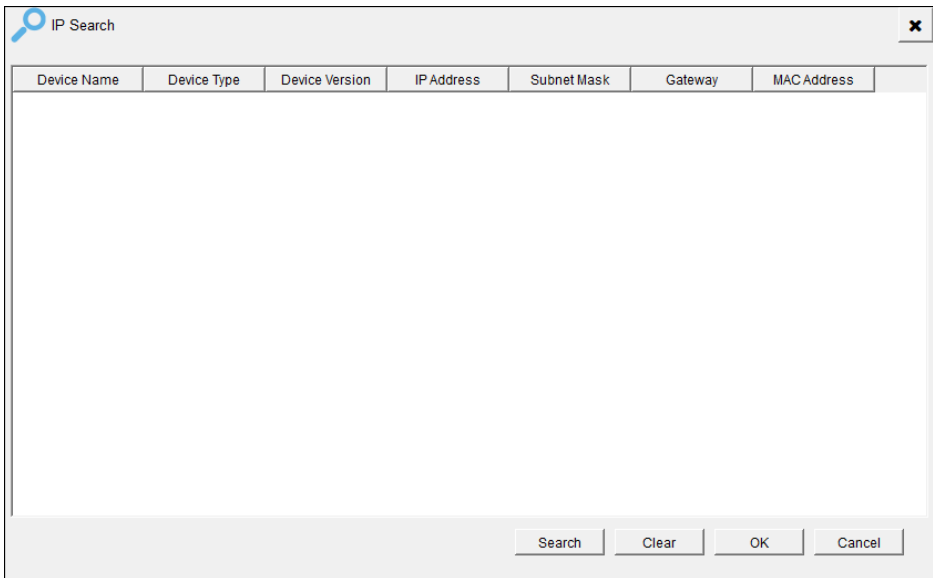

Fig 3.1 IP Config tool

Under “NET” tab, click “search”, it will display the IP address of each equipment in this LAN. The IP address of HD Matrix, is displayed as shown in figure 3.2

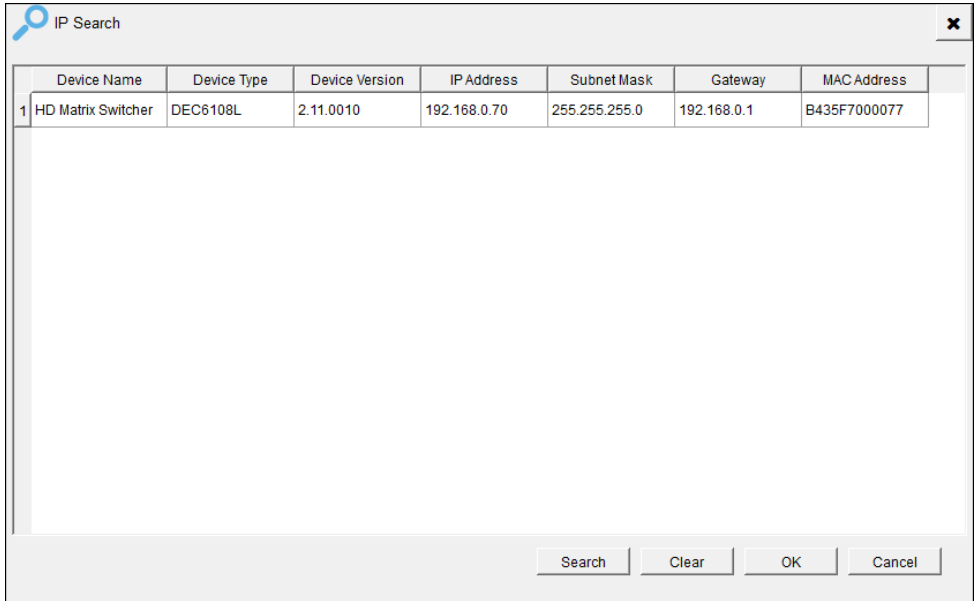

Fig 3.2 IP Config Search Info

Part 4 Matrix configuration

4.1 Log in to matrix configuration menu

After starting the device, the system requires users to log in and allocate corresponding functions according to the user permission.

IP address: Use IpConfig.exe to find out the IP address.

Note: Default IP address is 192.168.0.70

Extract the ConfigTool.zip and run “MatrixConfig.exe”, Select English as the preferred language on the top right corner, then input User name and Password to log in the HD Matrix configuration interface.

(Default User Name: admin Password: 12345), fig 4.1 is below.



English

IP MATRIX CLIENT

Ip Address

User Name

Password

2.11.0001

Fig 4.1 matrix configuration login interface

After Login the client, the workbench interface as shown below (Based on the actual shipping version) , Fig4.2:

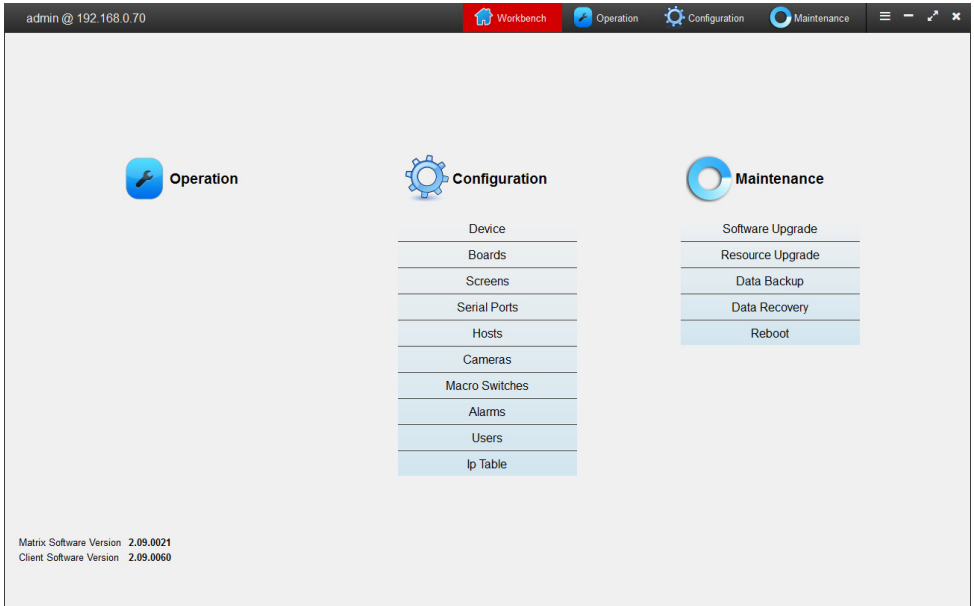

Fig 4.2 Interface of workbench

Below are the configuration menu list:

【Device】: Check and set the equipped IP keyboard parameter, set the output code stream pattern and the OSD parameters.

【boards】: Check current boards number, and the internal communicating IP address among boards.

【Hosts】 : Check and set the access hosts parameter (stream media server, alarm gateway server, etc)

【Cameras】 : Check and set the access for IP cameras and RTSP devices

【Screens】 : Check and set the output interface parameter

【Macro Switches】 : Set patrol, group, split switch functions.

【Alarms】 : check and set the link with networking alarm devices.

【Users】 : Check and set the users' ID and password

【IP Table】 : Check and set the IP address of every single external board

Maintenance function list as shown below:

【Software Upgrade】 : Upgrade the device's firmware

【Resource Upgrade】 : Upgrade the device's source file

【Data Backup】 : Download the device's database to local computer

【Data Recovery】 : Upload database to device from local computer to overwrite

4.2 Device configuration

4.2.1 System

Click “Device” at configuration interface and display the interface as below.

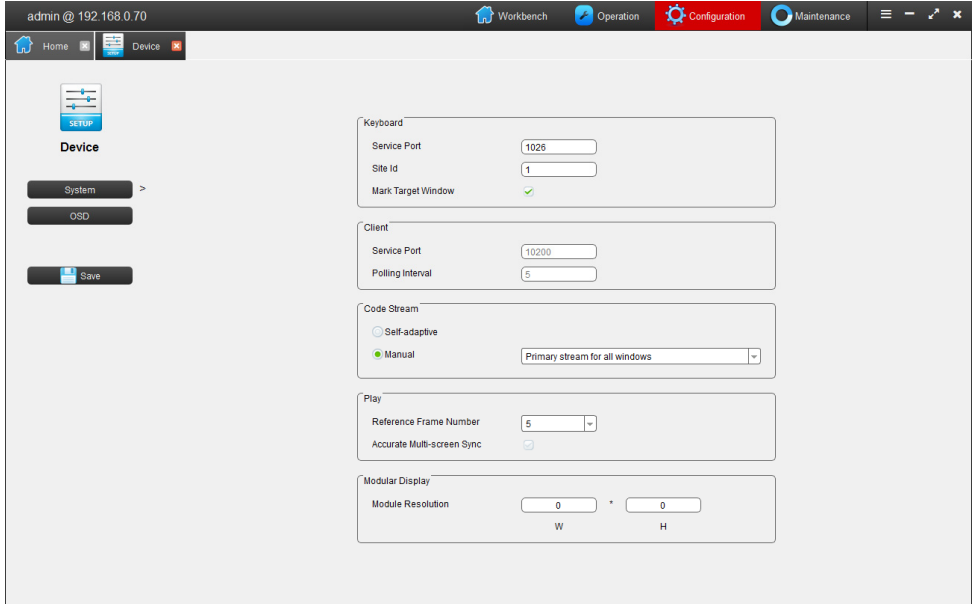

Fig 4.3 system

Click “System”, the Service Port and Site Id of IP keyboard can be configured, Service Port and Heartbeat Interval of Client can be checked. After configuration click “Save”.

Default setting of the bit stream is “Automatic” mode, manually optional bit stream mode. Three mode: “Primary stream for all windows”; “Primary stream for full screen windows”; “Primary stream for 2*2 split windows”.

Reference frame number: default 5, 2-9 can be set. The smaller of number, the more real of video.

4.2.2 OSD

Click “OSD” in the “Device” interface and go to OSD configuration interface. Fig shows as below.

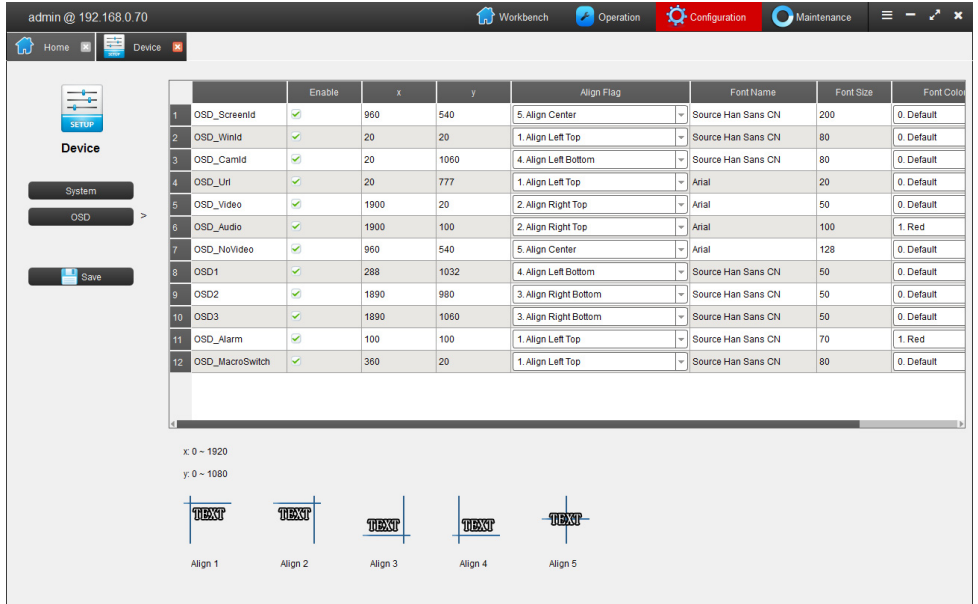

Fig 4.4 OSD

At OSD settings interface, the OSD(including window number, camera number, monitor number, audio switch status, warning message) can be set to display, coordinate and alignment, font style and size of OSD can be configured. After configuration click “Save” to make it valid.

Note: For some configurations(change IP address, monitor resolutions, etc), all operation that needs “save” will take effect after reboot. Wait for 30 seconds after settings.

4.3 Board configuration

Click “Boards” and the current board information can be checked.

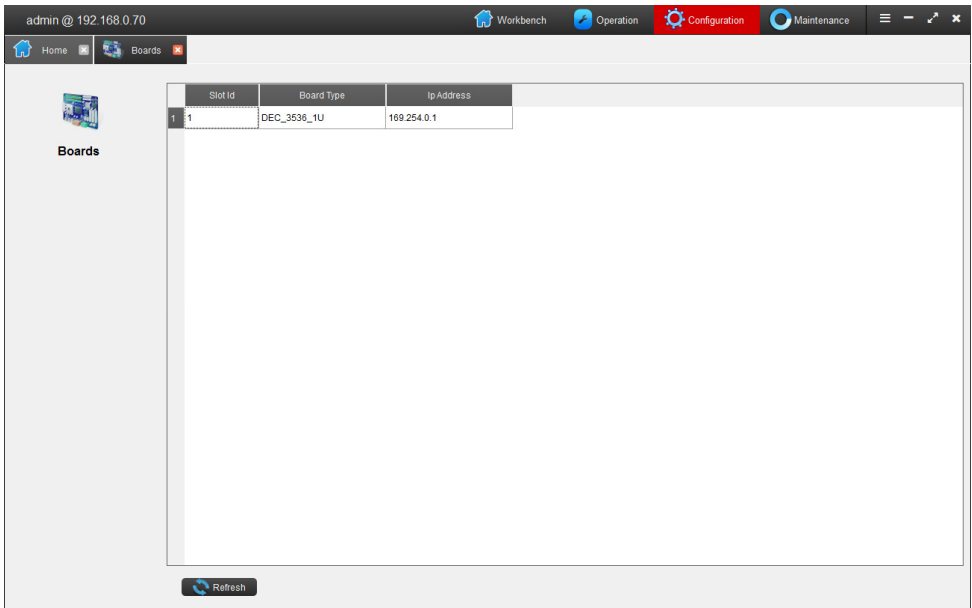

Fig 4.5 Boards

Board address: The internal IP address among boards. Numbers of ip address depend on the board numbers. Board numbers determine the screens that matrix can create. Usually, one board creates 2 screens. Board IP address is related to the slot number. The last number of IP address is the same as the slot number. When device reboots, it will search boards automatically. Click “refresh” to check current board number and board parameter. When the actual quantity of boards doesn't match the board quantity that has been searched out, the device runs abnormally. Please contact the after-sale team for help.

4.4 Host configuration

Click on the “Hosts” at in the interface of matrix configuration and display into hosts interface as below.

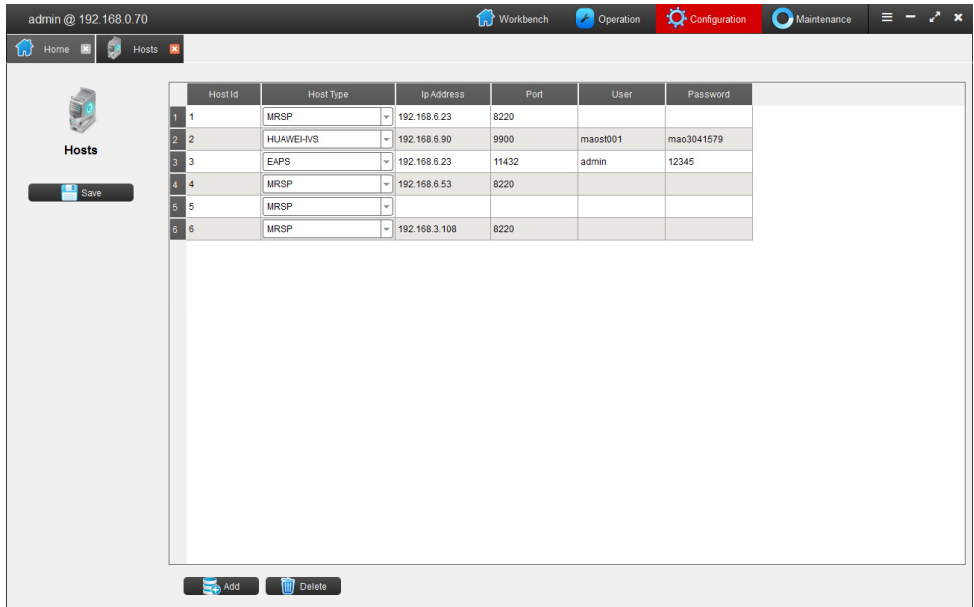

Fig4.6 stream media configuration

Host type, IP address, Port No. can be configured in this interface.

Host type can be MRSP , EAPS and HUAWEI-IVS .

When host type is MRSP, IP address is MRSP host address; Default port No. is 8220; When host type is EAPS, IP address is EAPS host IP address, default port No. is 11432, User name/password is pm/123456789. When host type is HUAWEI-IVS, IP address is HUAWEI server's, default port No. is 9900, User name/password is configured by HUAWEI client.

Note: @ : / \ are not supported in User name and password

4.5 Camera Configuration

Click “Cameras” in the matrix configuration interface and come into cameras configuration interface. All access cameras will be listed here. Fig 4.7 as below.

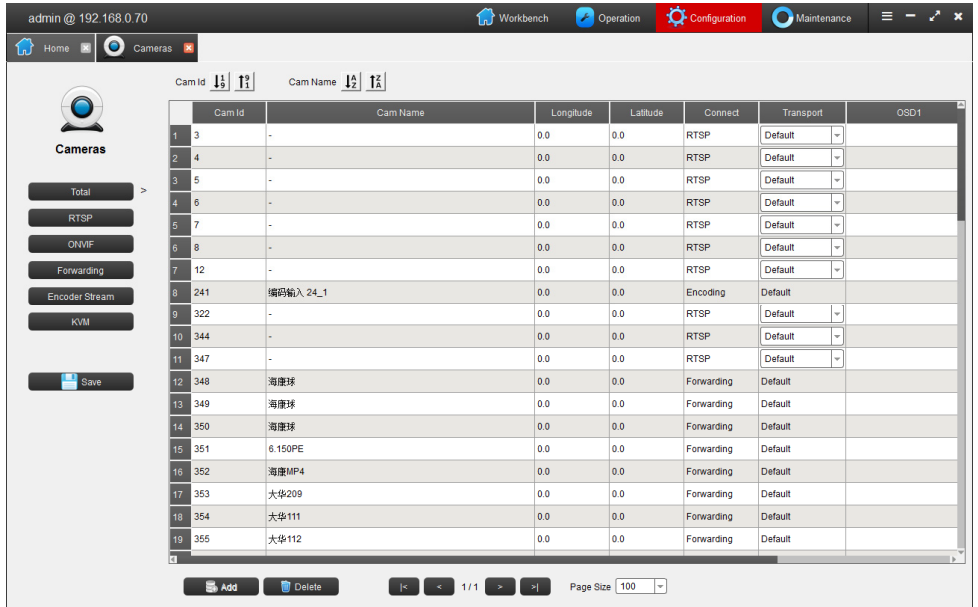

Fig 4.7 camera configuration

Click “Total” to show all identified devices including RTSP streams, ONVIF access & stream access.

One or more cameras can be “deleted” in this interface, and line number of each single page can be set.

4.5.1 RTSP Configuration

Select “RTSP” and come into RTSP interface as below.

The screenshot shows a web interface for camera configuration. At the top, there is a navigation bar with tabs for Home, Cameras, Workbench, Operation, Configuration (selected), and Maintenance. Below the navigation bar, there is a sidebar on the left with a 'Cameras' icon and several buttons: Total, RTSP (selected), ONVIF, Forwarding, Encoder Stream, KVM, and Save. The main area contains a table with the following columns: Cam Id, Cam Name, Longitude, Latitude, Transport, and Video. The table lists 16 cameras with their respective IDs, names, coordinates, transport protocols, and video streams.

	Cam Id	Cam Name	Longitude	Latitude	Transport	Video
1	3	-	0.0	0.0	Default	rtsp://192.168.6.23/4K.mkv
2	4	-	0.0	0.0	Default	rtsp://192.168.6.23/4K_H264.mkv
3	5	-	0.0	0.0	Default	rtsp://192.168.6.23/2.mkv
4	6	-	0.0	0.0	Default	rtsp://192.168.6.23/SONY.mkv
5	7	-	0.0	0.0	Default	rtsp://192.168.6.23/isyd.mkv
6	8	-	0.0	0.0	Default	rtsp://192.168.6.23/4K_H264.mkv
7	12	-	0.0	0.0	Default	rtsp://192.168.6.23/8554/monitor1
8	322	-	0.0	0.0	Default	rtsp://192.168.6.162/554/dm10
9	344	-	0.0	0.0	Default	rtsp://192.168.6.164/554/dm10
10	347	-	0.0	0.0	Default	rtsp://192.168.6.162/554/ch1
11	376	-	0.0	0.0	TCP	rtsp://192.168.6.248/554/dm10
12	381	-	0.0	0.0	Default	rtsp://192.168.6.162
13	427	-	0.0	0.0	Default	rtsp://192.168.6.174/554/ch1
14	428	-	0.0	0.0	Default	rtsp://192.168.6.174/554/ch2
15	429	-	0.0	0.0	Default	rtsp://192.168.6.174/554/ch3
16	430	-	0.0	0.0	Default	rtsp://192.168.6.174/554/ch4

At the bottom of the interface, there are buttons for 'Add' and 'Delete', along with navigation arrows and a page size dropdown set to 100.

Fig 4.8 RTSP List

Click “Add” to manually edit the camera name, RTSP address, etc. Select the camera in the list and click “Delete” to delete the camera.

4.5.2 ONVIF configuration

Select “ONVIF” and display the ONVIF interface. Fig 4.9 shows as below.

The screenshot shows the ONVIF configuration interface. On the left, there is a sidebar with a 'Cameras' icon and several buttons: Total, RTSP, ONVIF (selected), Forwarding, Encoder Stream, KVM, and Save. The main area is titled 'Probe Results' and contains a large empty box. To the right of this box are input fields for 'User Name' (admin) and 'Password' (admin), along with 'Probe', 'Authenticate', and 'Add' buttons. Below the 'Probe Results' section is a table titled 'Onvif Cameras' with columns for Cam Id, Cam Name, Longitude, Latitude, Ip Address, User, and Password. The table contains 11 rows of camera data. At the bottom of the interface, there are 'Add' and 'Delete' buttons, navigation arrows, a page indicator '1 / 1', and a 'Page Size' dropdown set to '100'.

Cam Id	Cam Name	Longitude	Latitude	Ip Address	User	Password
1	414 3440HD_Series 192.168.6.252 VideoToken_chn1	0.0	0.0	192.168.6.252	admin	admin
2	415 3440HD_Series 192.168.6.252 VideoToken_chn2	0.0	0.0	192.168.6.252	admin	admin
3	416 3440HD_Series 192.168.6.252 VideoToken_chn3	0.0	0.0	192.168.6.252	admin	admin
4	417 3440HD_Series 192.168.6.252 VideoToken_chn4	0.0	0.0	192.168.6.252	admin	admin
5	418 DS-2CD6332FWD-I 192.168.6.197 VideoSourceConfig_1	0.0	0.0	192.168.6.197	admin	admin12345
6	419 DS-2CD6332FWD-I 192.168.6.197 VideoSourceConfig_2	0.0	0.0	192.168.6.197	admin	admin12345
7	420 DS-2CD6332FWD-I 192.168.6.197 VideoSourceConfig_3	0.0	0.0	192.168.6.197	admin	admin12345
8	421 DS-2CD6332FWD-I 192.168.6.197 VideoSourceConfig_4	0.0	0.0	192.168.6.197	admin	admin12345
9	422 3440HD_Series 192.168.6.248 VideoToken_chn1	0.0	0.0	192.168.6.248	admin	admin
10	423 3440HD_Series 192.168.6.248 VideoToken_chn2	0.0	0.0	192.168.6.248	admin	admin
11	424 3440HD_Series 192.168.6.248 VideoToken_chn3	0.0	0.0	192.168.6.248	admin	admin

Fig 4.9 ONVIF List

In the ONVIF list, Click “Probe” to search out the front device that supports onvif protocol in the network. Select one or some items and “Authenticate” them. There is status reminds for failed or successful authentication. Select the verified camera and click “Add” to add the camera to the ONVIF list.

Figure shows as below.

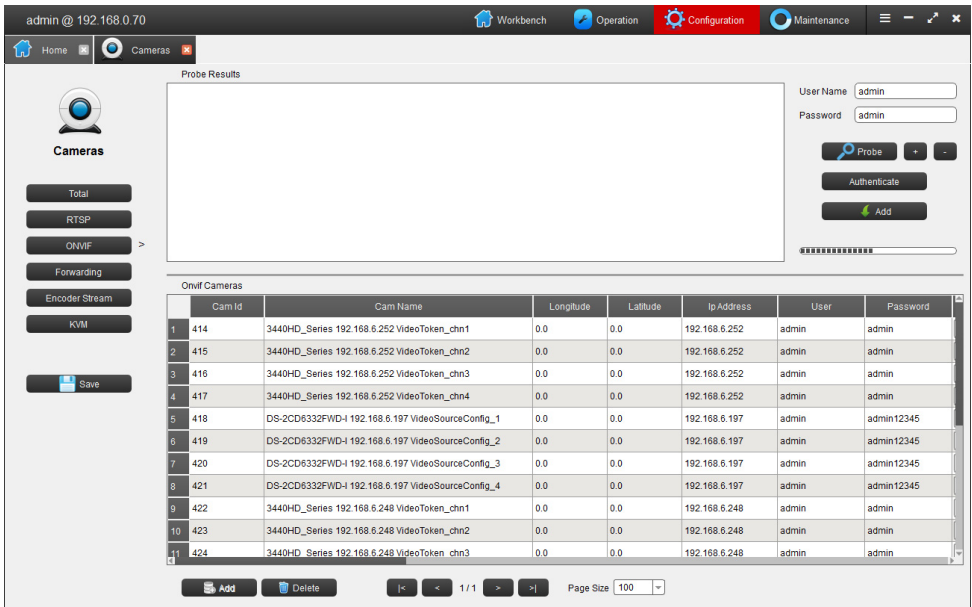

Fig 4.10 ONVIF access

For convenient check, IP address and authenticating status of cameras which have been searched out or authenticated can be sorted

[User name] [password] : user name and password of front device, it can be used in authentication. User name and password support digital and English case.

Camera number, name and parameters of cameras which is in the camera list can be changed.

Click “+” and add one camera configuration line. Input the IP address of camera which needs to be authenticated, to authenticate it alone. Click “-” to delete the camera configuration line that is selected.

Note: default user name and password is admin. @ : \ / are not supported in User name and password

4.5.3 Stream configuration

Select “Forwarding” and display the forwarding interface. Fig 4.11 shows as below.

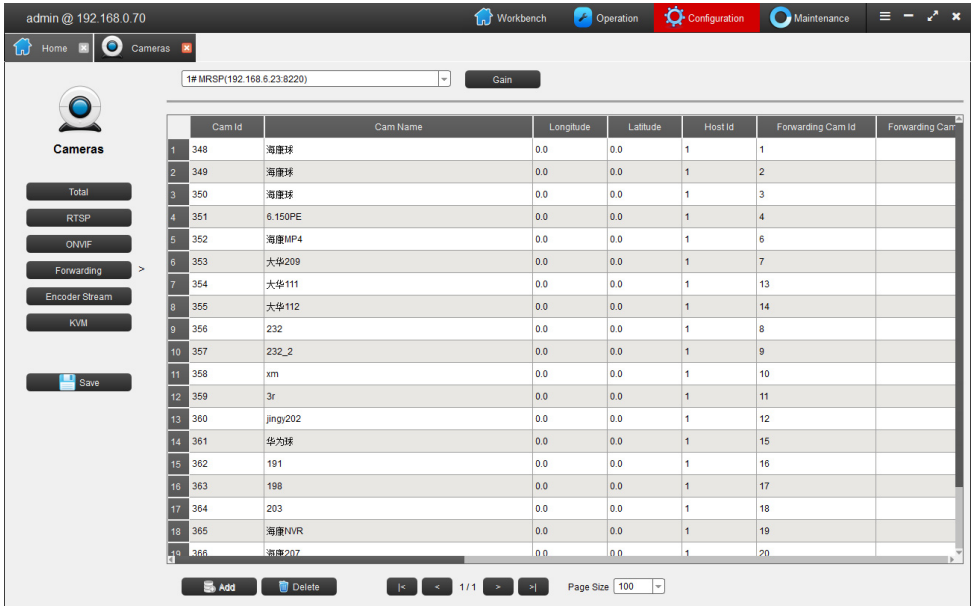

Fig 4.11 Forwarding list

In the forwarding interface, select the host No. in the combo box and click “Gain” to gain the forwarding access camera.

4.5.4 Encoder Stream

Select “Encoder Stream” and the config interface as shown below, Fig 4.12:

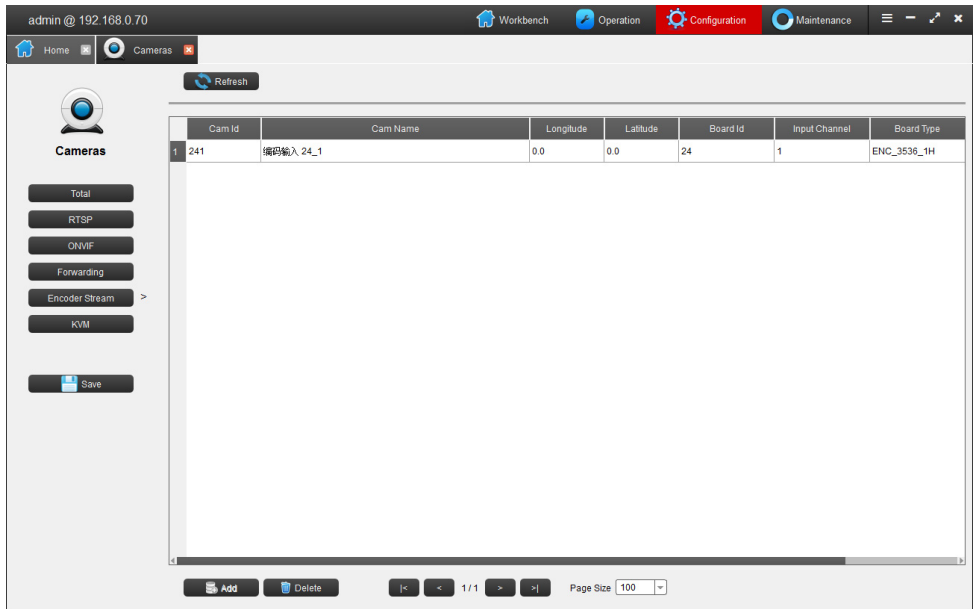

Fig4.12 Encoder stream interface

In the menu you can refresh to search the encoders and make configuration.

4.5.4 KVM

Select “KVM” the interface as shown below, Fig4.13

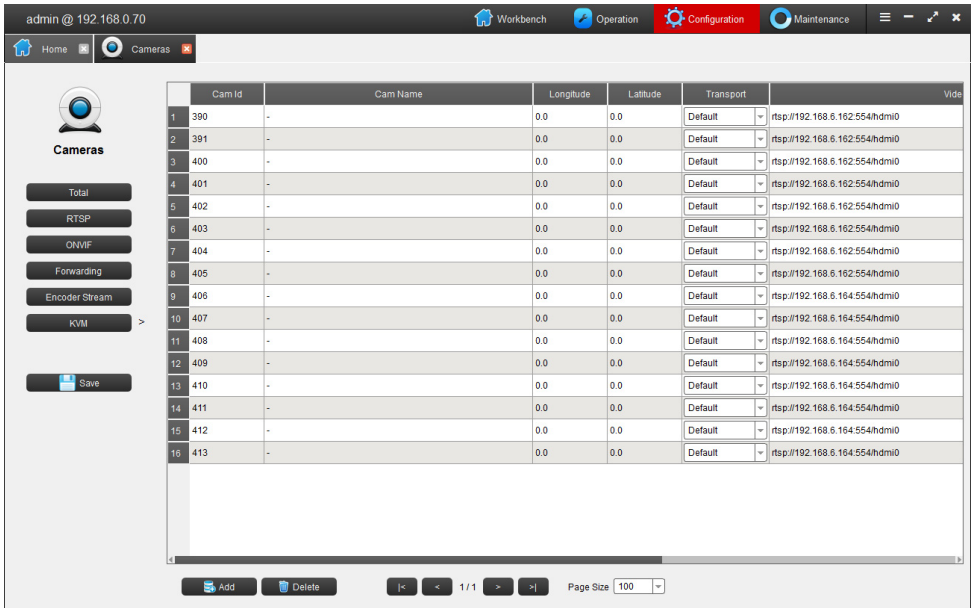

Fig.4.13 KVM interface

Click “Add”,you can add new camera and fill up the camera’s name, rtspaddress, etc.

Select the camera in list, can click “delete”, you can remove the camera

4.6 Video Screens configuration

Click “Screens” in the matrix configuration interface and display the screen configuration interface. Fig 4.14 shows as below.

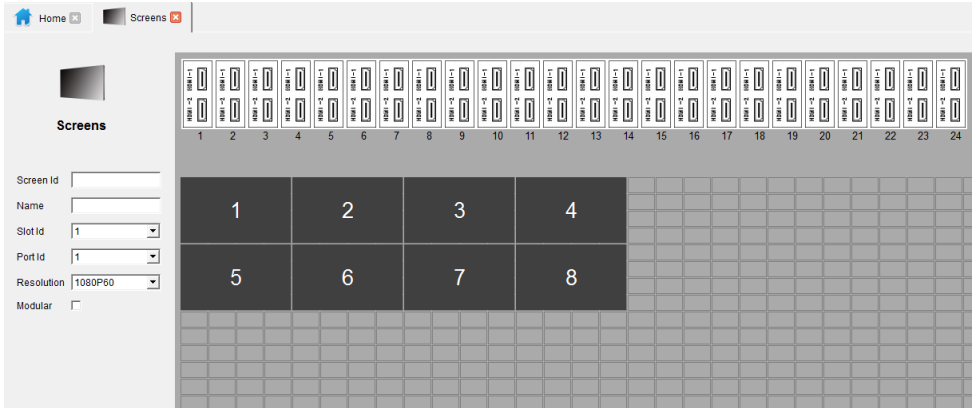

Fig 4.14 Screens configuration

Click “Clear” to clear all screens or select one or some of them then click “Delete” to delete the selected ones.

Screens parameters will show in the left. Screen ID and name can be set. Slot ID, Port ID and resolution can display here and default resolution is 1080P60. Resolution can be changed in the pull-down list.

Note: The quantity of created monitors is as twice as slot quantity.

Click any Screen ID, and it will dynamically link the HDMI output of the board and indicate the corresponding output port of current screen. Fig 4.15 shows as below.

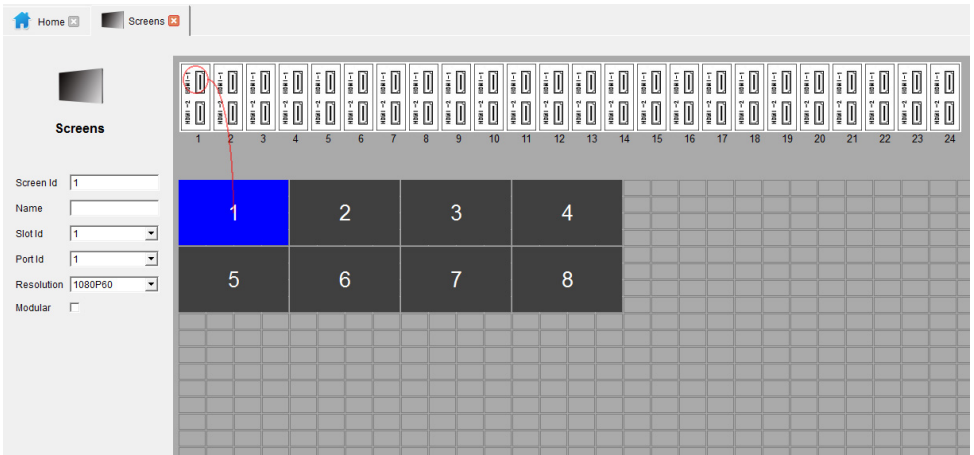

Fig 4.15 Screen link

4.7 Macro Switches

Click “Macro Switches” in the configuration panel and invoke the macro switches configuration interface, Fig 4.16 shows as below.

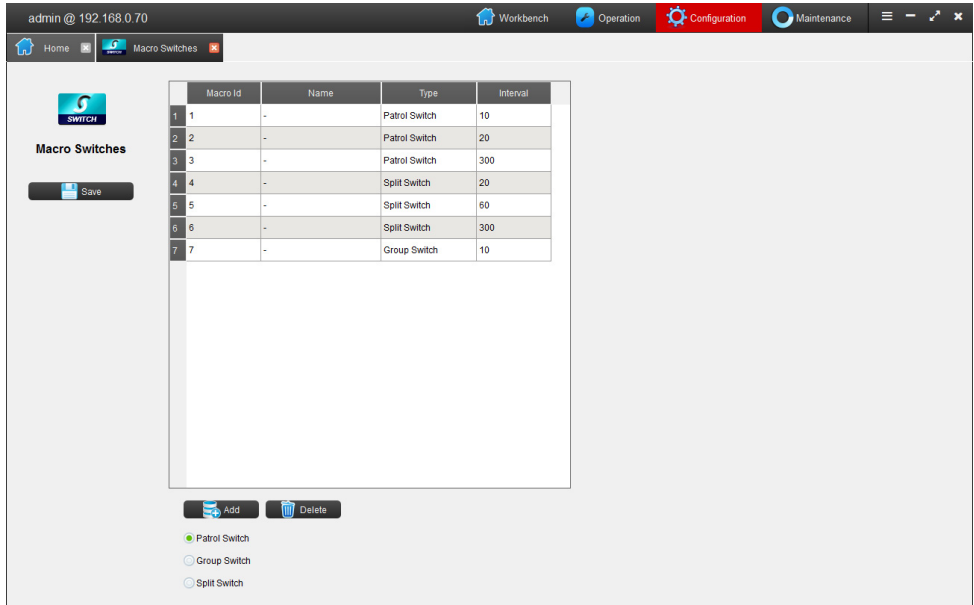

Fig 4.16 macro switches

In “Macro Switches”, user can configure “Patrol Switch”, “Group Switch”, “Split Switch”.

【Patrol Switch】 specify one window to do auto-cycle viewing.

【Split Switch】 specify one monitor to split then do auto-cycle viewing.

【Group Switch】 specify a group of windows to do auto-cycle viewing at the same time.

4.7.1 Patrol Switch

Click “Patrol Switch”, the camera configuration area will display as Fig 4.17 as shown below.

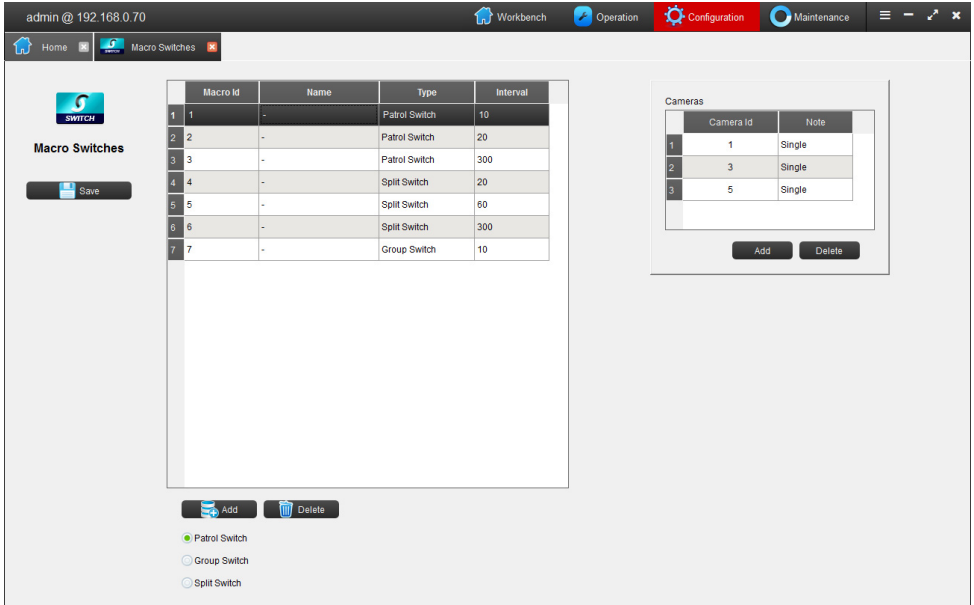

Fig 4.17 patrol switch

Camera number which will patrol can be filled in “Camera Id”. It can add alone, range, all. Multiple lines can be added. After finish, all cameras in the list will patrol switch.

Note: (1) Default camera No. is “0”, it means select all cameras in the camera list.

(2) User can add cameras by range, like “3-5”, it means 3, 4, 5 camera is added in the patrol list.

4.7.2 Split Switch

Click “Split Switch”, Split mode and camera configuration will display at right area in Fig 4.18 as shown below.

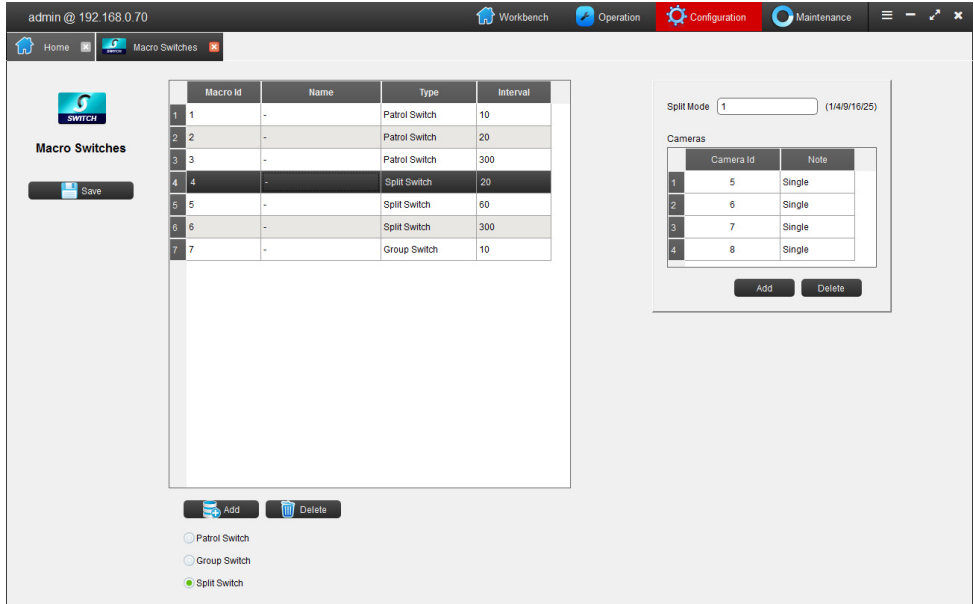

Fig 4.18 split switch

In “Split Switch”, select 1/4/9/16/25, add the camera No. in “Camera Id”, single, range, or all items can be added, it can add multi lines. After adding, all cameras in the list can do Split Switch.

Note: (1) Default camera No. is “0”, it means select all cameras in the camera list.

(2) User can add cameras by range, like “3-5”, it means 3, 4, 5 camera is added in the split switch list.

4.7.3 Group Switch

Click “Group Switch”, Windows and camera configuration will display at right area in Fig 4.19 as shown below.

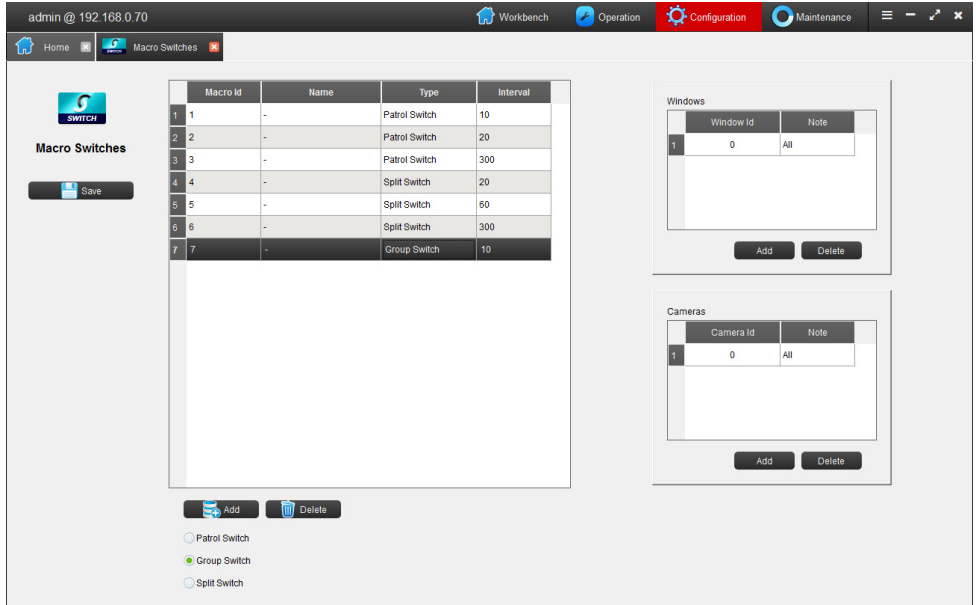

Fig 4.19 Group Switch

Input the “Window Id” and “Camera Id”, single, range, or all items can be added, also can add multi lines. After adding, all cameras in the list can do Group Switch.

Note: (1) Default camera No. is “0”, it means select all cameras in the camera list.

(2) User can add cameras by range, like “3-5”, it means 3, 4, 5 camera is added in the group switch list.

4.8 Alarms

Click “Alarms” in the matrix configuration interface and invoke the alarm configuration interface Fig 4.20 as shown below.

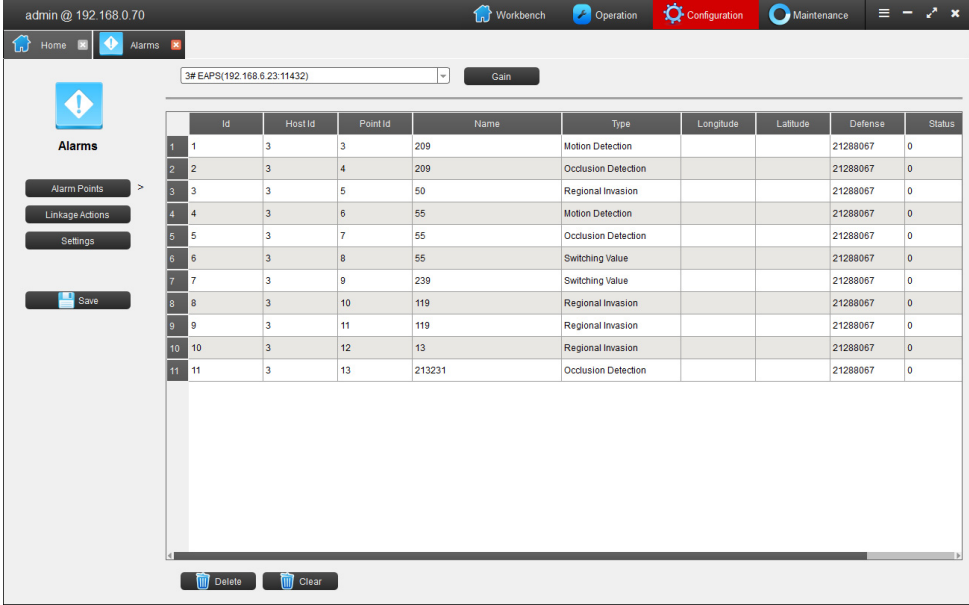

Fig 4.20 Alarm

It can obtain the alarm point of EAPS, can configure “linkage action”, “settings”. (requires additional hardware)

4.8.1 Alarm point

Click “Alarm point” as in Fig 4.21 as shown below.

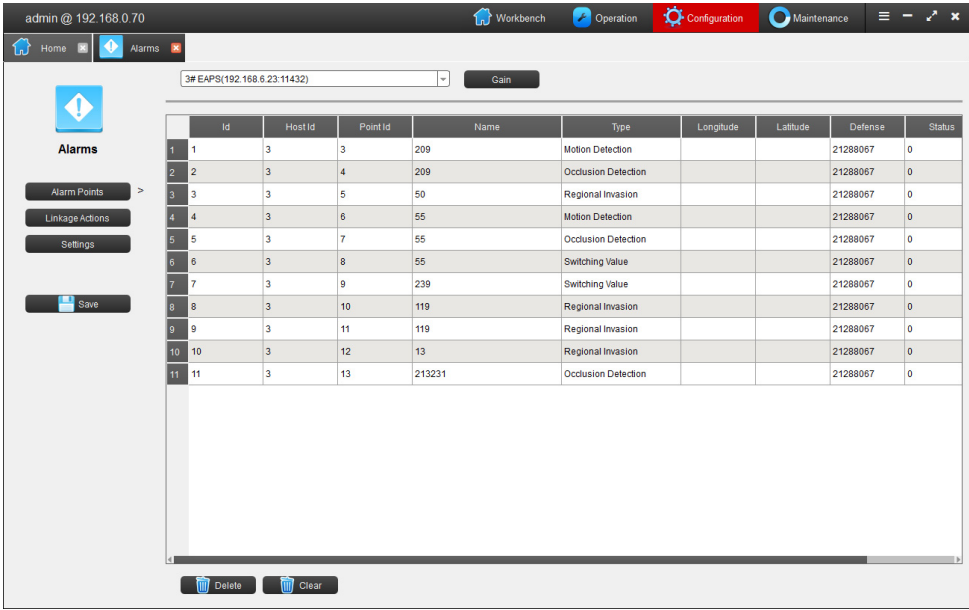

Fig 4.21 alarm point

In Alarm point tab, select alarm server host ID in the dropdown list and click “Gain”, the matrix can obtain all alarm point and related information from server.

4.8.2 Linkage actions

Click “linkage actions”, it will show alarm point and linkage actions configuration box as in Fig 4.22 as shown below.

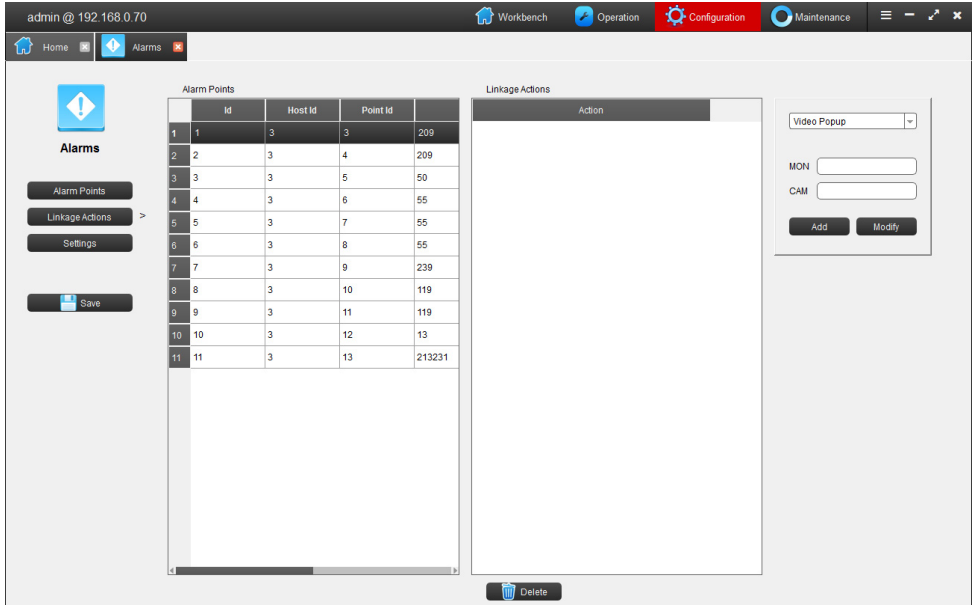

Fig 4.22 linkage actions

In “linkage actions” tab, select alarm point and configure the linkage actions when the alarm point is triggered.

Linkage actions can be video popup or go to preset.

Select “Video Popup”, input “MON” and “CAM”, then when alarm point is triggered, N MON will display M CAM (eg. 1MON, 2CAM).

Select “Go to Preset”, input “CAM” and “PRESET”, then when alarm point is triggered, M CAM N Preset will be called (eg.1CAM, 2PRESET).

4.8.3 Settings

Click “Settings” tab, it will show “settings” interface in Fig 4.23 shown below.

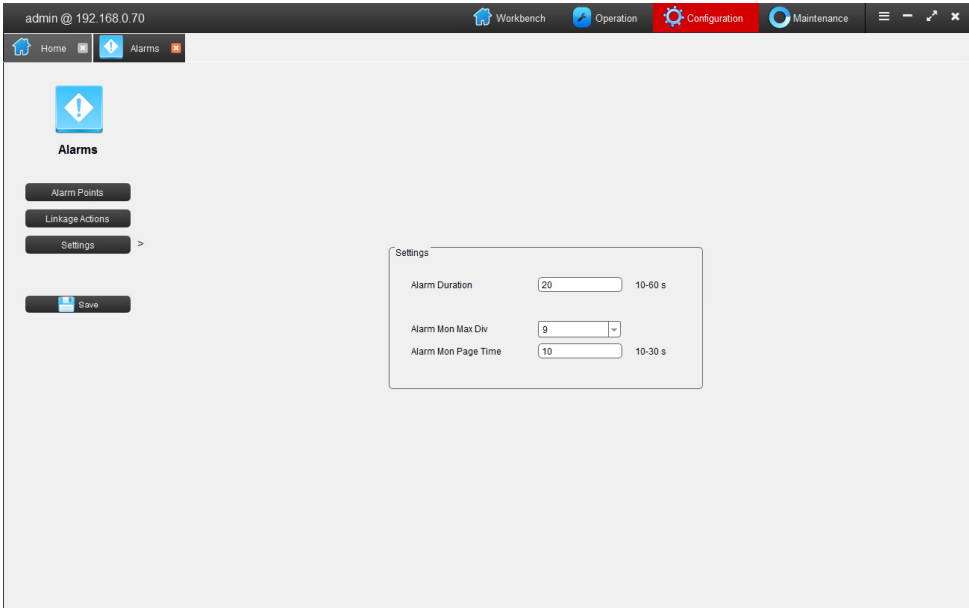

Fig 4.23 Settings

In “Settings” tab, “Alarm Duration” can be set, from 10-60 seconds options.

“Alarm Mon Max Div” can be set as 1,4,9,16,25.

“Alarm Mon Page Time” can be set from 10-30 seconds.

4.9 User configuration

Click “Users” in the matrix configuration interface and invoke the user configuration interface as in Fig 4.24 shown below.

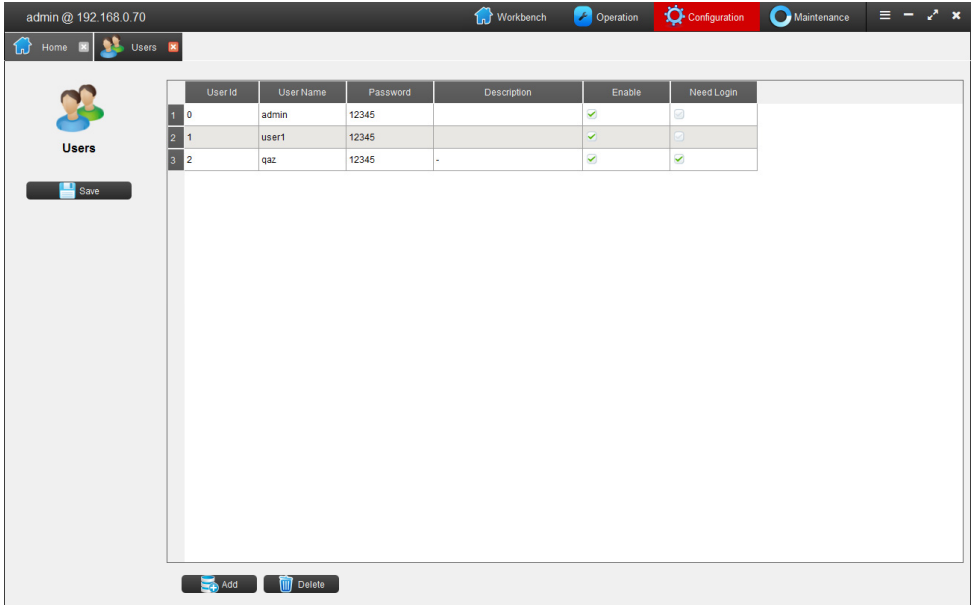

Fig 4.24 User configuration

A user can be added, deleted, and user name/password can be modified in the user configuration interface.

Default user ID is 0 for Admin account.

User name: admin; Password: 12345.

4.10 IP Table configuration

Click “IP Table” in the matrix configuration interface. Fig 4.25 as shown below.

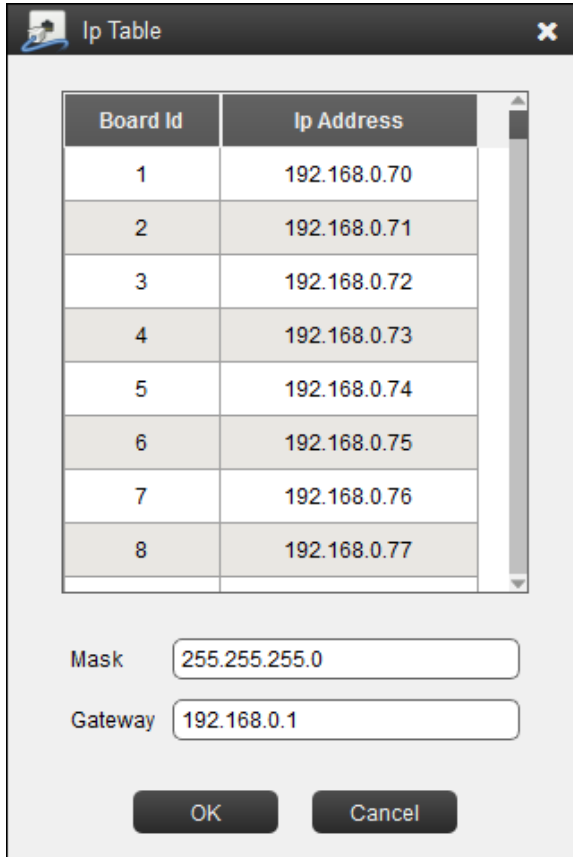

Fig 4.25 IP Table

External IP address, subnet mask, and gateway of every single board in the matrix can be set in the IP Table

Note: *IP address of each board in the matrix should be on the same network. When boards are connected with network cable, IP address must be set, or the device will run abnormally.*

4.11 Maintenance

Click “Maintenance” in Workbench, interface as shown below, Fig4.26:

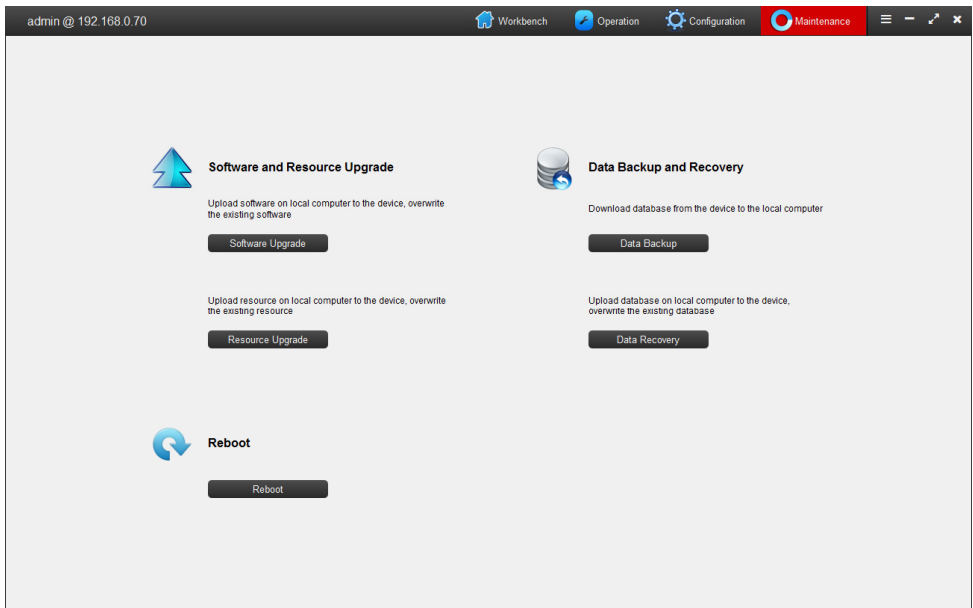

Fig4.26 Maintenance

【Software Upgrade】 : Upgrade the device’s firmware

【Resource Upgrade】 : Upgrade the device’s source file

【Data Backup】 : Download the device’s database to local computer

【Data Recovery】 : Upload database to device from local computer to overwrite

【Reboot】 : Reboot the matrix

4.12 Operation

In the Workbench, click “Operation” to enter the operation interface, as shown Fig4.27:

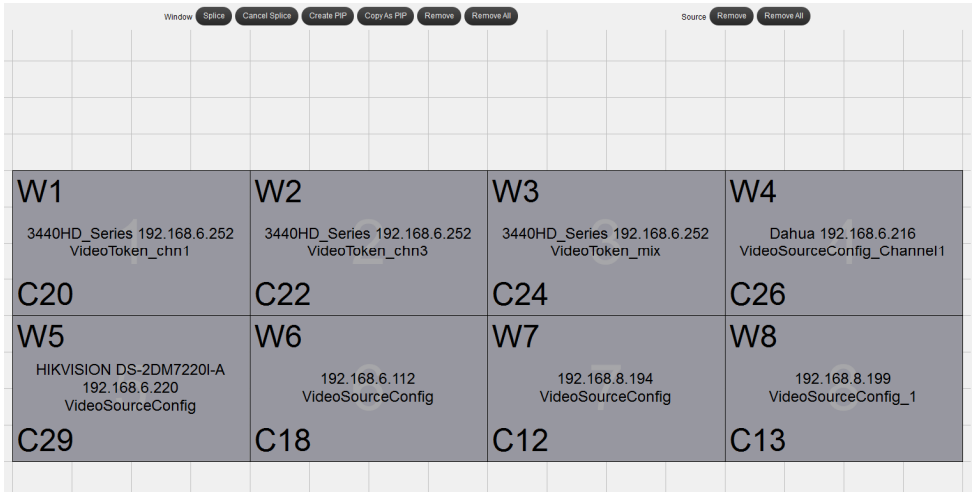

Fig4.27 Operation

4.12.1 Splitting&Splicing

In the “Operation” interface, make splitting&splicing to windows, Fig4.28:

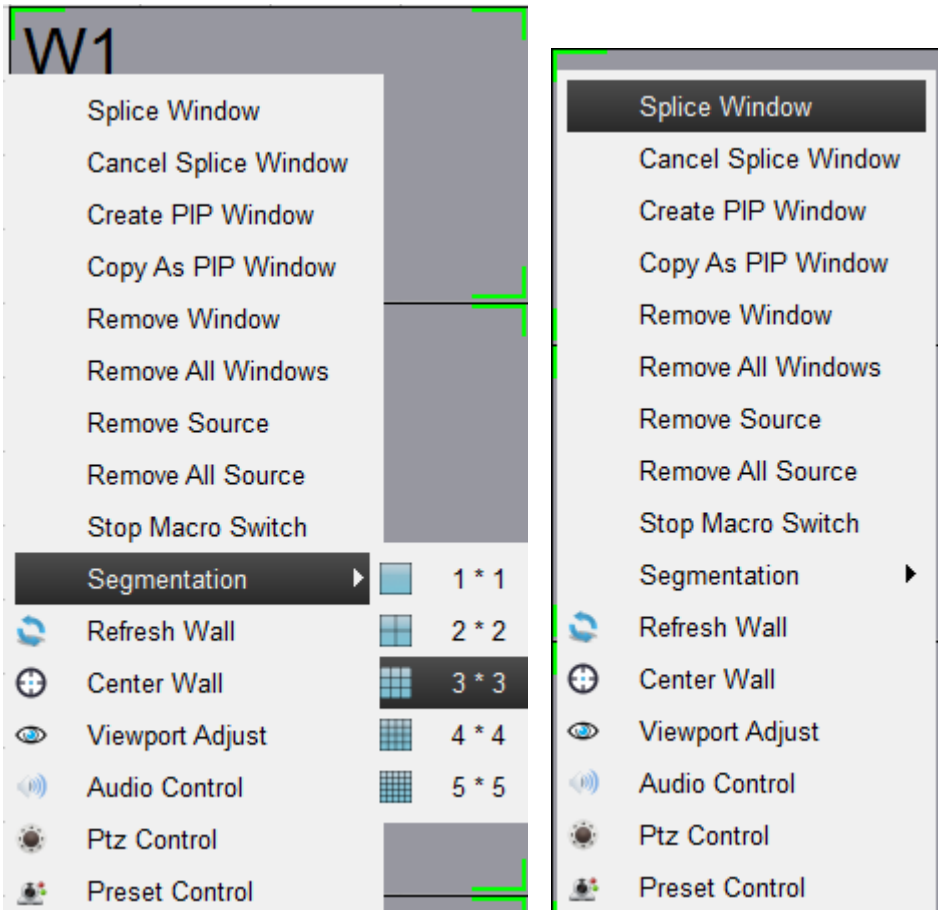

Fig4.28 Windows splitting&splicing

Click left mouse to select windows, and click right mouse and select segmentation

4.12.2 Audio control&PTZ Control

In the “Operation”interface, make audi control&PTZ operation, Fig4.29:

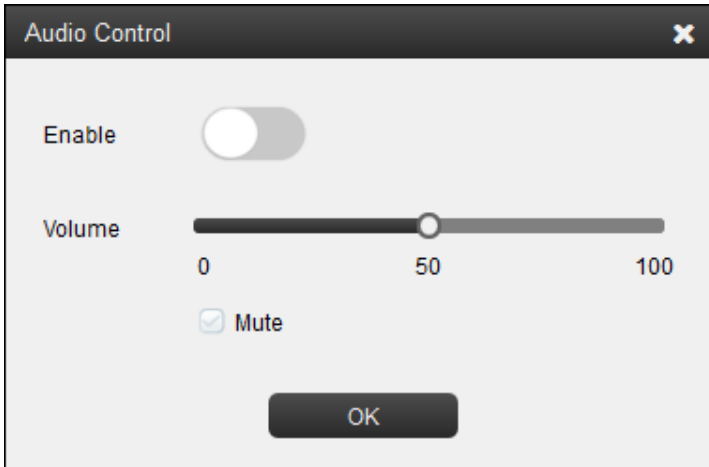

Fig4.29 Audio & PTZ control

Select one window,click right mouse button to choose audio control or PTZ control.

Audio can be switched on/off, or adjust the volume and mute.

PTZ button to control cameras.

4.12.3 Macros

In the left bottom of “Operation” interface, there is a macro function, as shown below:

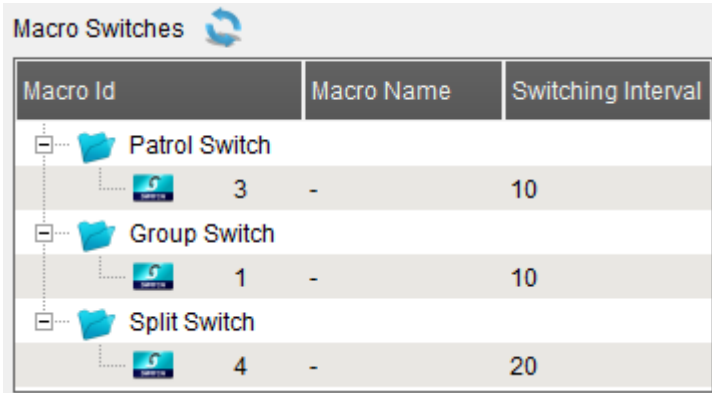

Macro Id	Macro Name	Switching Interval
3	Patrol Switch	10
1	Group Switch	10
4	Split Switch	20

Fig 4.30 Macros

Macro ID: The number of the matrix switching configuration plan, such as 1, 2, and so on. Switching configuration plans include patrol, grouping, and segmentation.

Macros status running or not: View the current running status of the switching configuration plans.

A、Patrol: Use mouse dragging macro number 3 to window 1, you can realize No. 1 window running number 3 patrol plan.

B、Grouping: Double-click on macro number 4 to run the numbered 4 group switching plan.

C、segmentation: Double-click on macro number 1 to run the number 1 split switch plan.

4.12.3 Plans & Preset control

In the left bottom of “Operation” interface, there is plan function menu, click “add” button the interface as shown below:

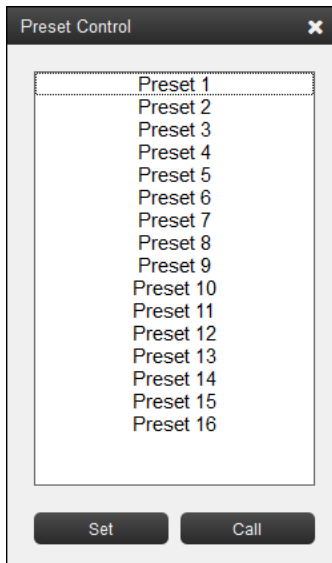
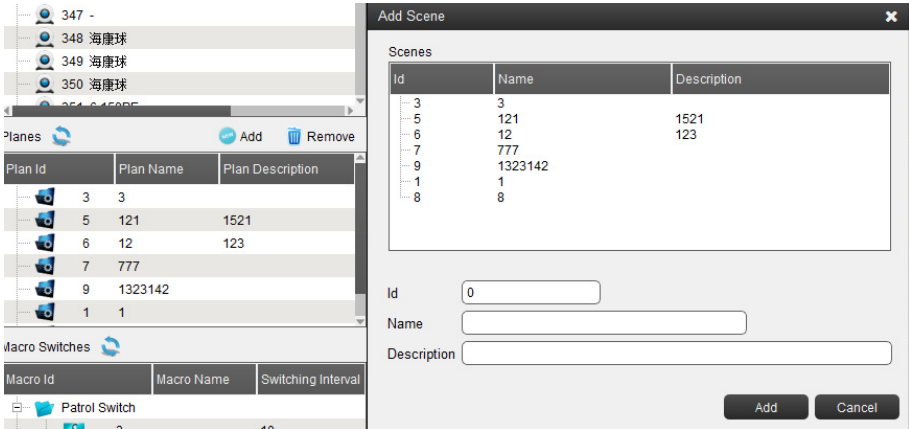

Fig 4.30 Plans & Preset control

Click “add” button to add new plan or revised the existing plans.

Can set preset control or calling

Part 5 Appendix

5.1 Specifications and parameters

Interface Parameter	
HDMI output	8ch HDMI
Ethernet	100M/1000M adaptive RJ45 port
Audio input	1ch ,Φ3.5 earphone socket .
Audio output	1ch ,Φ3.5 earphone socket .
Video Parameter	
network video decoding	H.265,H.264, MPEG4
network video input	4K,1080P,1080I,720P,D1
HDMI output resolution	1024×768P@60Hz,1280×720P@60Hz, 1366×768P@60Hz,1920×1080P@60Hz, 3840×2160@60Hz(only HDMI 2/4/6/8 support3840*2160)
video decode and display	8CH 4K or 64ch 1080P or 128ch 720P or 256ch D1
monitor splicing	8 monitor splicing
monitor splitting and display	Support 1/4/6/8/9/10/16/25 splitting and display
OSD	Supports Window, channel, label, etc. display
Audio	
Audio Codec	G.711,G.726,AAC Audio encode/decode.
On/Mute	Supports all channels and single channel quick setting individually.
Audio input	one module support 1CH audio encode, it can be set to open/close audio input.
Management and Maintenance	

Basic function	Multi-user login/logout; users operation permission definition; Supports video switching and controlling. Support Cruise, patrol, split, display mode management, Plan configuration and call.
System management and configuration	PETNET protocol available, Net client or platform can configure and manage, users operation permission definition & management
Maintenance	system log available. System status detection Fault detection and report. support online updating.
Other	
time synchronization	interior RTC, it could time automatic synchronization in cascading , offer standard port, to keep sync. To time server inside the system.
alarm input	support network alarm input
alarm output	Support alarm video linkage
power supply	AC 100-220
working temperature	0~55℃
working humidity	10%~90%;
Dimension	482.0*371.3*44.0mm
Weight	4.0KGS

5.2 HD Matrix fault analysis and debugging

In case of a fault or trouble, please analyze possible cause as follows.

If the issue is not resolved, please contact the dealer or manufacturer.

Failure or Trouble	Analysis	Resolution
POW indicator is off	Power fault	Check the power connector Check the power-supply
No image output	Single power supply	Check indicator of power supply
	Display unit connection	Check the connection between the display and matrix. Check the HDMI cable and connector
Video output is abnormal	Display unit connection	Check the connection between display unit and matrix The quality of HDMI cable.
Still /frozen image	Network cable connection	Check the network connection for this image, check the green indicator light on Ethernet port. Check the Ethernet input port of this video, if the yellow light (data) blinking or not.

5.3 communication matrix

Source device and IP	Source port	Destination device and IP	Destination port (intercept)	protocol	Port Desc.	If Port and firewall can change or open	Authentication and encryption	Command to close Port
External device and IP	1024 ~ 65535	Decoding matrix and IP	18220	UDP	search	no	none	none
External device and IP	1024 ~ 65535	Decoding matrix and IP	9999	TCP	upgrade	no	none	none
External device and IP	1024 ~ 65535	Decoding matrix and IP	9911	UDP	reboot	no	none	none
External device and IP	1024 ~ 65535	Decoding matrix and IP	9980	TCP	file	no	none	none
External device and IP	1024 ~ 65535	Decoding matrix and IP	9900	TCP	Control during cards	no	none	none
External device and IP	1024 ~ 65535	Decoding matrix and IP	10200	UDP	C-S (SDK)	no	none	none
External device and IP	1024 ~ 65535	Decoding matrix and IP	1026	UDP	Keyboard	no	none	none
External device and IP	1024 ~ 65535	Decoding matrix and IP	9555	TCP	RTSP	no	none	none

External device and IP	1024 ~ 65535	Decoding matrix and IP	9520	TCP	cluster	no	none	none
External device and IP	1024 ~ 65535	Decoding matrix and IP	9200	TCP	control	no	none	none
External device and IP	1024 ~ 65535	Decoding matrix and IP	9554	TCP	RTSP	no	none	none
External device and IP	1024 ~ 65535	RTSP server and IP	RTSP server port	TCP、UDP	/	/	/	/
External device and IP	1024 ~ 65535	IVS server and IP	IVS server port	TCP、UDP	/	/	/	/
External device and IP	1024 ~ 65535	ONVIF device and IP	ONVIF device port	TCP	/	/	/	/

5.4 User list

User name	password	type	functions	Factory status	Amendment method
admin	12345	admin	configure and operate	enable	amend in configuration page
user1	12345	operator	operate	enable	amend in configuration page

